



# *Oceania Sun Lounges*

*By Woodpecker Joinery UK LTD*

*Established 1994*

*A Building For All Seasons*

*[www.oceaniasunlounges.co.uk](http://www.oceaniasunlounges.co.uk)*

*Oceania Sun Lounges is part of Woodpecker Joinery, founded in 1994 by Christopher Waltho, a dedicated and talented craftsman.*

*From a farming background, an early memory was spending many hours helping his father lovingly craft a wooden greenhouse. His natural and creative flare for design became apparent during Chris' school days, as did his love for and interest in working with wood. Chris went on to study woodwork at NVQ level and gained a City and Guilds certificate. Along the way many things added to career development; serving an apprenticeship at the age of 17 with a local joinery company manufacturing doors, conservatories and windows, and in the engineering field acquiring knowledge of design. A lifelong dream had been to one day start his own business.*

*Since starting the business in 1994 a reputation for good quality products grew, as did a customer base. Chris began to develop a website and engineer a range of Western Red Cedar greenhouses and garden buildings. Orders flowed in and eventually it became too much work for one person. Realizing the need for help he approached his brother Louis, fiancée Louise, cousin Joe and Tom, a family friend. Long hours, hard work and dedication were called for - together we were a strong and determined team. The popularity of our products exceeded expectations; we were full of optimism and looking forward to the future. This led to the development of the Sun Lounge range of all season garden buildings.*

*We have exported our products to Ireland, France, Belgium, Denmark, Germany, Falkland Islands and even as far as Australia! We import all of our PEFC certificated cedar direct from Canada. We continue in the development of young people and training within the workplace with our established apprenticeship scheme which ensures our craftsman skills are passed on to the next generation.*





*Kalbarri Sun Lounge*

*Manufactured entirely from Western Red Cedar*



*The Sun Lounge range is handmade in our Staffordshire workshops*



*Guild of Master Craftsmen continues a long established tradition of bringing together skilled artisans engaged in a trade, craft or profession in order to safeguard the interests of the public and ensure they receive a premium service from recommended tradesmen.*



*UK mainland delivery and installation is included with all our buildings  
Oceania installs using our own trained craftsman  
No extra charge for Scottish highlands  
We have experience of exporting our range of buildings into Europe, USA and Australia*



*Members of the Federation adhere strictly to current European Standards and Codes of Practice. Any person buying from a member company of the TTF does so in the knowledge that they are dealing with a company committed to its products, the environment and to an exceptional standard of service.*



Member of the  
Timber Trade Federation

*Woodpecker Joinery has been making cedar garden buildings since 1994. We have a vast experience of manufacturing large domestic and commercial buildings from our workshops. Woodpecker Joinery has been privileged to be approached and receive two successful Royal commissions. We have also undertaken various projects for the National Trust including two large greenhouses for their Blickling Estate.*

*EST. 1994*



*Sydney Sun Lounge*

## *Sydney Sun Lounge*

*Available with roofing options of cedar shingles, glazing, Tapco slate or a combination.*

*Add a little luxury with the Sydney Sun Lounge. A perfect sanctuary whether relaxing in private or sharing an afternoon with friends. Make the most of your garden by creating an idyllic setting. On a warm summers day or a cosy place to share as slowly the seasons change and the golden glow of Autumn appears - the Sydney is a wonderful retreat. A luxurious lounging area to entertain discerning guests for pre-dinner drinks. It makes a perfect dining area and will be a spectacular addition to your home. A wealthy choice of luxurious cushions and matching blinds are available with rich and colourful fabrics. We will create the perfect ambiance and the ultimate in outdoor living for you.*

*Includes-*

- Cushioned seating (range of colours available)*
- Scatter cushions*
- Dual switch heater*
- Mood lighting*
- Table (with glass top)*

*We pride ourselves in having the resources available to complete bespoke projects - any scale or size. By managing everything in-house, we ensure that all design details are professionally managed.*

*As our Sun Lounges are made to order, the internal design of each building can be manufactured to your bespoke requirement. Interior seating and scatter cushions are made in Staffordshire by a team of skilled seamstresses.*

*We have completed commissions for architectural tenders, artistic concept designs and replacement of cedar structures which are both complex and completely bespoke in nature.*



*Sydney Sun Lounge*



*Each interior is tailor made to your own specification*

*8ft x 10ft Sun Lounge*



## Layout Options

The below layout plans demonstrate some configurations for our Sun Lounge. However any layout is possible and bespoke changes can be made, at no extra cost, to suit your individual requirement.

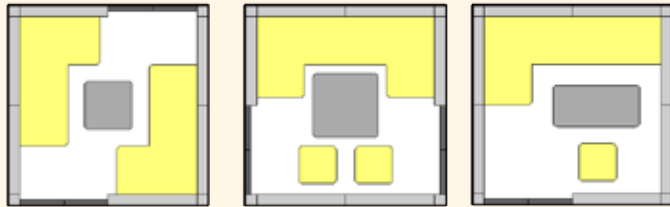
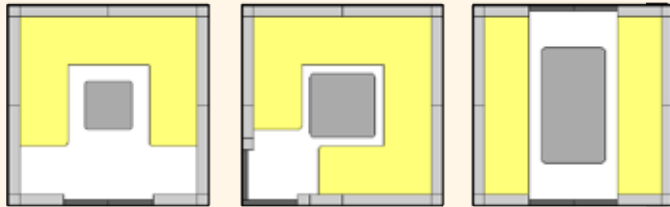

8ft x 8ft

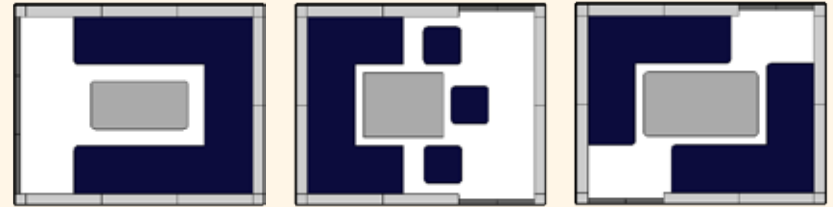
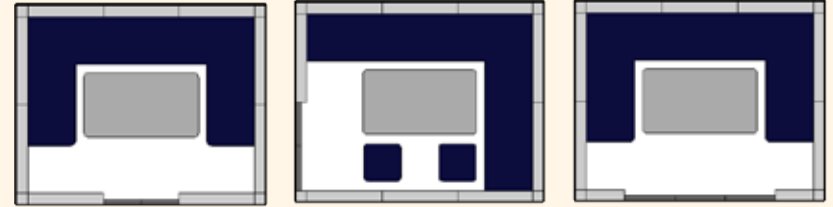

8ft x 10ft

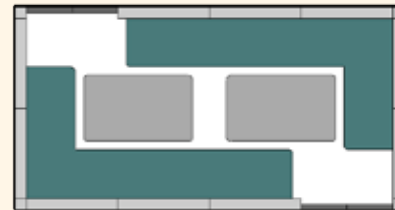
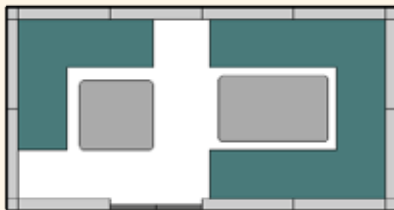
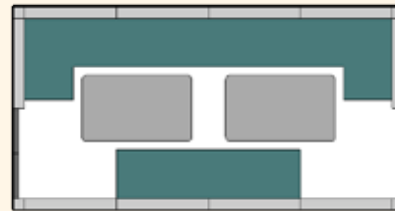

8ft x 16ft

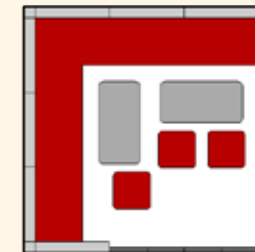
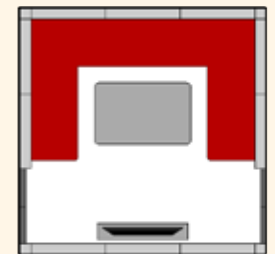
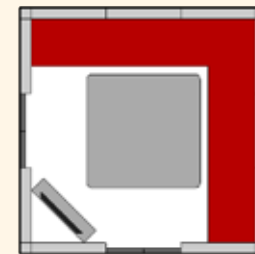

12ft x 12ft

*8ft x 8ft Sydney Sun Lounge*



*Our unique glazed roof provides natural light perfect for reading*



*Location and style of shutter doors can be chosen to suit your needs*

*8ft x 12ft Sydney Sun Lounge*



*8ft x 12ft Sun Lounge*

*Perfect for an evening of entertaining*



*8ft x 8ft Sun Lounge*

*Designed for British Weather*

*12ft x 12ft Sun Lounge*



*Bi-fold doors, insulation and double glazing can be fitted as optional extras*

An 8ft x 10ft wooden sun lounge with a shingled roof, situated on a paved patio in a garden. The structure is made of light-colored wood and features large glass doors and windows. The roof is covered in reddish-brown shingles. The sun lounge is surrounded by greenery, including trees and bushes, and is set on a circular paved area with a stone border. The background shows a brick wall and more trees.

*8ft x 10ft Sun Lounge*

*A shingled roof has a unique appearance and requires minimal maintenance*

## Decagonal Sun Lounge

Available with roofing options of cedar shingles, glazing, Tapco slate or a combination.

Transform your outdoor space while enjoying the comfort and style of our decagonal Sun Lounge. Ideal for outdoor modern living combining elegance with a classic appearance. Having a choice of cedar shutters, glazed or panelled sides provides a solution for shade on a hot summer's day and, with our unpredictable weather, shelter for guests should the clouds burst. Using the finest Western Red Cedar, our Sun Lounges are crafted with over 20 years of manufacturing experience. Created for you to enjoy the great outdoors all year round!

Includes-

- Cushioned seating (range of colours available)
- Dual switch heater
- Mood lighting
- Scatter cushions
- Table (with glass top)

Seating  
Capacity (max)

8ft x 6ft Mindil

2.4m x 1.83m

Five

8ft x 8ft Cottlesloe

2.4m x 2.4m

Seven

8ft x 10ft Glenelg

2.4m x 3m

Nine

10ft x 10ft Bondi

3m x 3m

Ten

10ft x 12ft Kalbarri

3m x 3.6m

Twelve

12ft x 12ft Byron

3.6m x 3.6m

Fourteen

12ft x 20ft Noosa

3.6m x 6m

Twenty



Bondi Sun Lounge





*Layout Options (other sizes are available)*

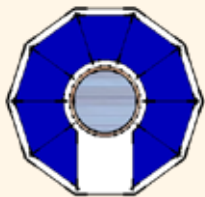

*8ft x 8ft  
Cottesloe*

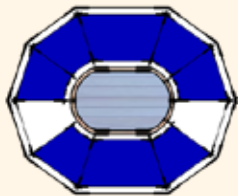

*8ft x 10ft  
Glenelg*

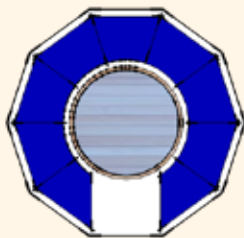

*10ft x 10ft  
Bondi*

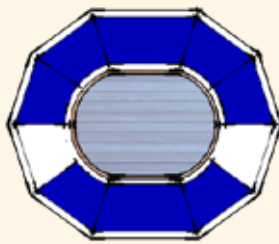

*10ft x 12ft  
Kalbarri*

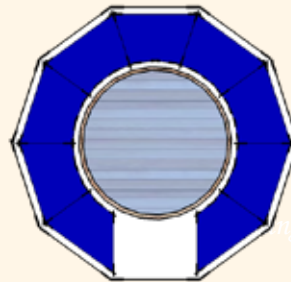

*12ft x 12ft  
Byron*

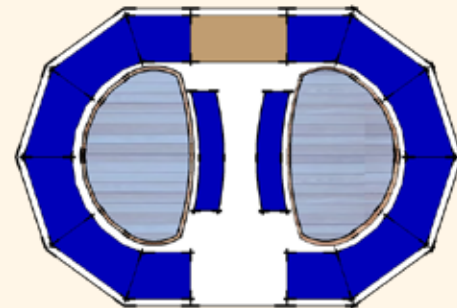

*12 x 20ft  
Noosa*

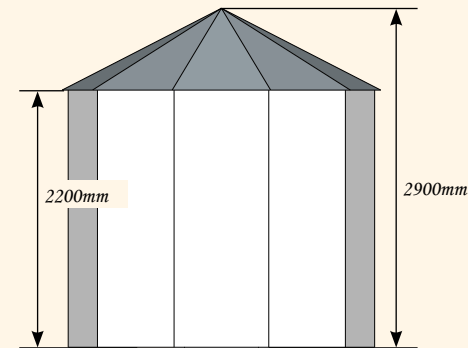
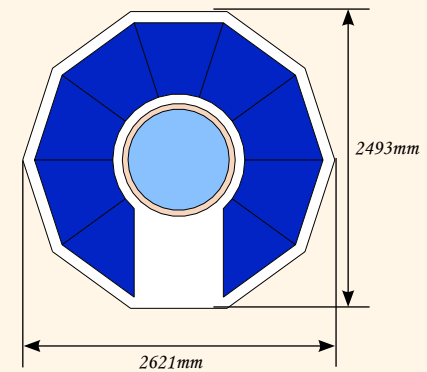

## 8ft x 8ft Cottesloe

Seats up to Seven

*Whether you want to entertain, dine or simply relax our Cottesloe Sun Lounge provides the perfect retreat. Being smaller in size it is an intimate yet comfortable environment to entertain friends and family. Perfect for the smaller setting. Constructed entirely of Western Red Cedar it provides insulation and warmth during the winter months. The shutter system provides ideal air circulation in the summer and combined with glazed sides allows for plenty of light.*

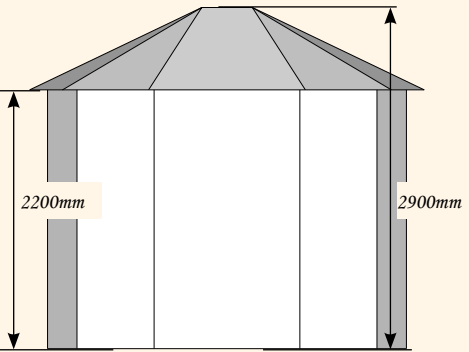
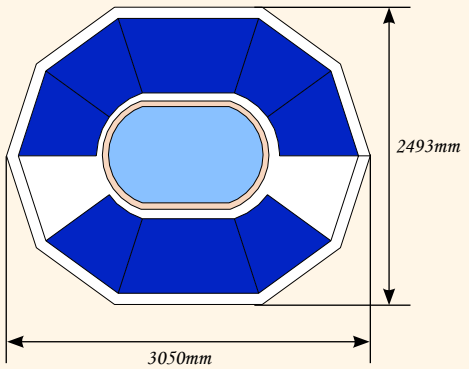

## 8ft x 10ft Glenelg

Seats up to Nine



*Transform your outdoor space while enjoying both comfort and style with our Glenelg Sun Lounge. It is ideal for outdoor modern dining whilst combining elegance with a classic appearance. Having a combination of cedar shutters, glazed or panelled sides available it provides shade on a hot summer's day and, with our unpredictable weather, shelter for guests should the heavens open.*

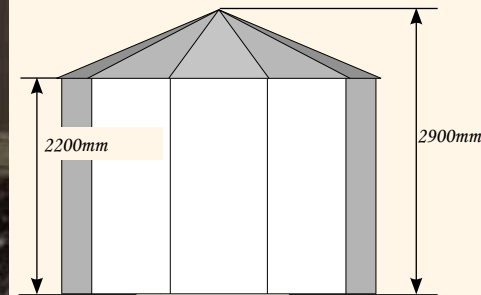
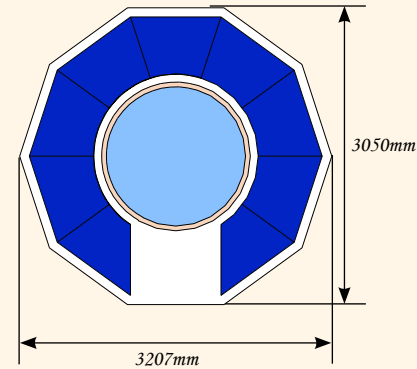

## 10ft x 10ft Bondi

Seats up to Ten

*Enhance your lifestyle with a stylish and comfortable Bondi Sun Lounge. The Bondi is ideal for you to host events and dine al-fresco with friends and family. Various options are available of glazed sides to give you natural light and panoramic views. The shutters create ventilation - ideal for warm summer days!*

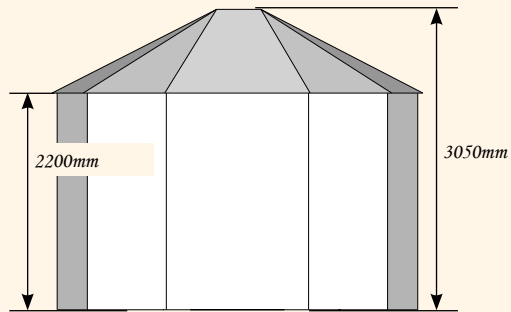
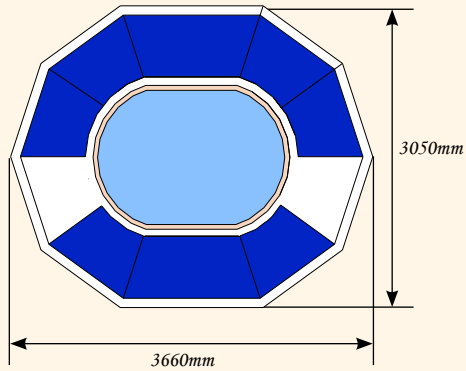

## 10ft x 12ft Kalbarri

*Seats up to Twelve*



*Imagine a welcoming and comfortable outdoor retreat. Add a little luxury with the Kalbarri Sun Lounge, a perfect sanctuary whether relaxing in private or sharing an afternoon with friends. Make the most of your garden by creating an idyllic setting whether it's a warm summers day or a cosy place to share as slowly the seasons change and the golden glow of Autumn appears. With the additional benefit of our cedar shutters for insulated warmth and glazed sides for sweeping views you have the best of both worlds.*



*Glenelg Sun Lounge*

*Our Sun Lounges are bespoke and can be manufactured individually to your required size*



*Noosa Sun Lounge*

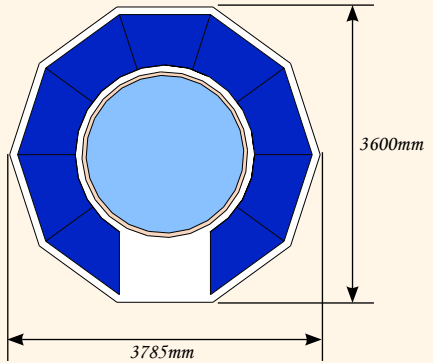

*12ft x 12ft*

*Byron seats up to Fourteen*

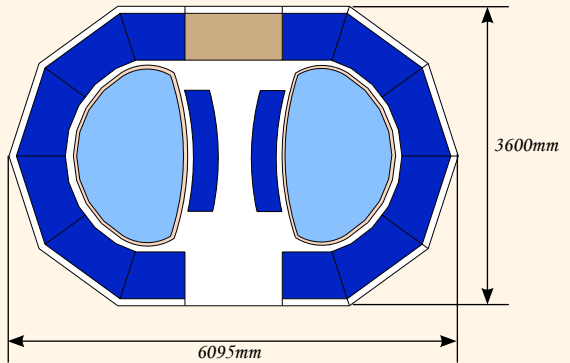

*12 x 20ft*

*Noosa seats up to Twenty*

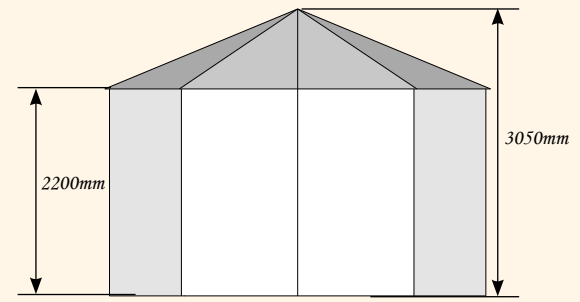



## Darwin Sun Lounge

Available with roofing options of cedar shingles, glazing, Tapco slate or a combination.



The Darwin Sun Lounge is perfect for those who desire to create a space which is a unique and interesting focal point of any garden. The asymmetrical style lends itself to creating two different areas within the building. Our 8ft x 16ft model (as pictured), has enough space to accommodate a comfortable dining area and seated relaxation ideal for pre-dinner drinks.

Includes-

- Cushioned seating (range of colours available)
- Scatter cushions
- Dual switch heaters
- Mood lighting
- Dining and coffee tables (both with glass tops)



## Layout Options

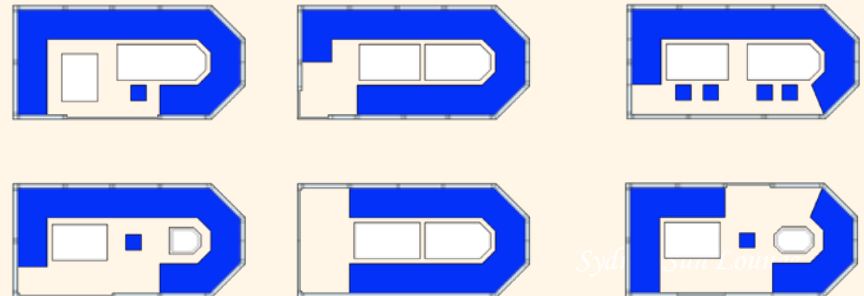

Style.com.au





*Designed to be cool in the summer, warm in the winter*



*The Darwin - fabulous for dining and all year round entertaining*

*Darwin Sun Lounge*



*Darwin Sun Lounge*

*Multi-functional : craft room, art studio or home office the choice is yours*



*Darwin Sun Lounge*





*Darwin Sun Lounge*



*Darwin Sun Lounge*



*Darwin Sun Lounge*

## *Cedar Shingled Roof*



*Kalbarri Sun Lounge*

*Western Red Cedar Shingles have been used as a roofing material with an extensive history of use by past generations on the north-west coast of North America. Cedar roofing and siding products require minimal maintenance. With time, cedar will turn to an attractive colour of silvery-grey. The unique properties of cedar ensures the building is kept cool in the summer and warm during the winter months.*



## *Glazed Roofing System*



*Sydney Sun Lounge*

*Oceania Sun Lounges offer a unique glazed system unlike any other. It has been designed with strength and safety in mind, with toughened, self cleaning safety glass fitted against a rubber gasket. Specially developed to leave no timber exposed and therefore has no requirement for maintenance. The aluminium capping bars are a design unique to Oceania - the system is discreet and engineered to fit securely with our timber rafters, ridges and roof gable joinery.*



*Sunbrella® Upholstery*



## *Sun Lounge upholstery*

*The Oceania Sun Lounge seating and cushions are created from 100% solution-dyed woven acrylic manufactured by the award winning Sunbrella®. The range of Sunbrella outdoor fabrics are available in various colours to suit any taste. As each Sun Lounge is made to order, the interior design of each building can be manufactured to any bespoke requirements. Fabrics meet the requirements of the Furniture and Furnishing Safety Regulations 1988 and chosen especially for their hard wearing qualities, without compromising comfort.*

*Our standard range of fabric is the Sunbrella 'In & Out' range. The Specially selected fabric is chosen for the following qualities-*

*~ Fade Resistant ~ Dry Clean or Machine Wash ~  
Soil, Oil, Stain and Water repellent*

*~ Five years fabric manufacturers warranty ~  
Colour fast against salt and chlorine water*

*For the upholstery simply choose:*

- The main colour for your seating*
- A piping colour*
- Scatter cushions are then made to match (as pictured)*

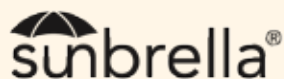

*Kalbarri Sun Lounge Interior*

## *Bespoke Design Service*

*Your Sun Lounge exterior will be personalised; with the option to specify a combination of glazed and panelled shutters around the perimeter of the building.*

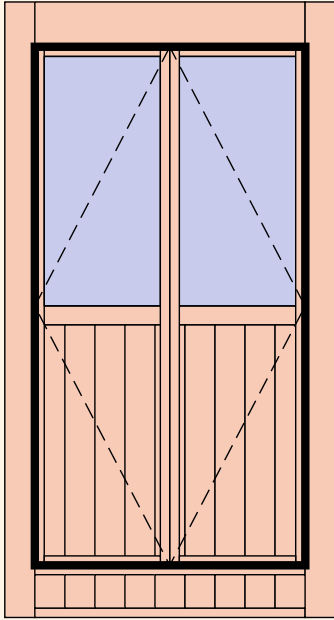

*Half glazed*

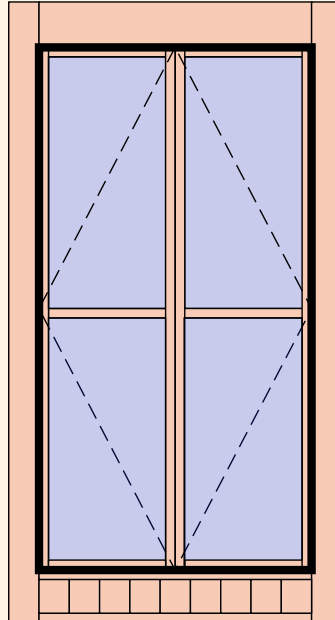

*Fully glazed*

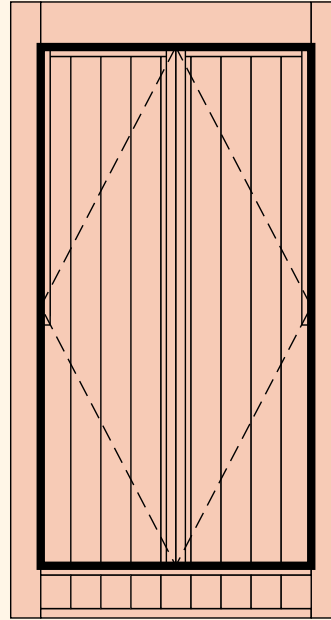

*Fully panelled*

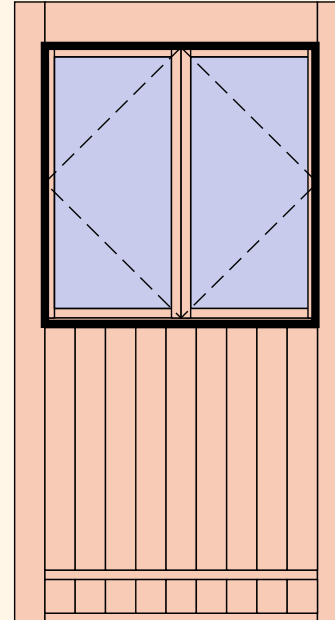

*Glazed shutter to  
open from midrail.  
Fixed panels below*

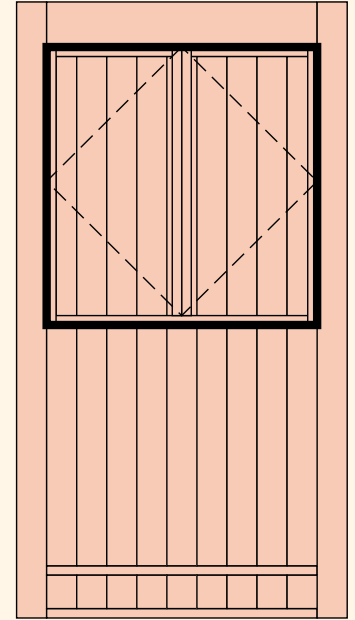

*Panelled shutter to  
open from midrail.  
Fixed panels below*

*All shutter types can be securely closed from the interior of the Sun Lounge and are fitted with an all weather rain and draft seal. The casements are fitted with corrosion resistant stainless steel hinges.*

*Glazed, shingled or Tapco slate are available as part of a Sun Lounge design. The options can be combined to offer different styles and also to provide discreet shading to individual areas of the Sun Lounge.*

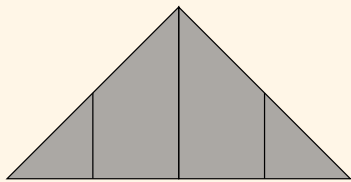
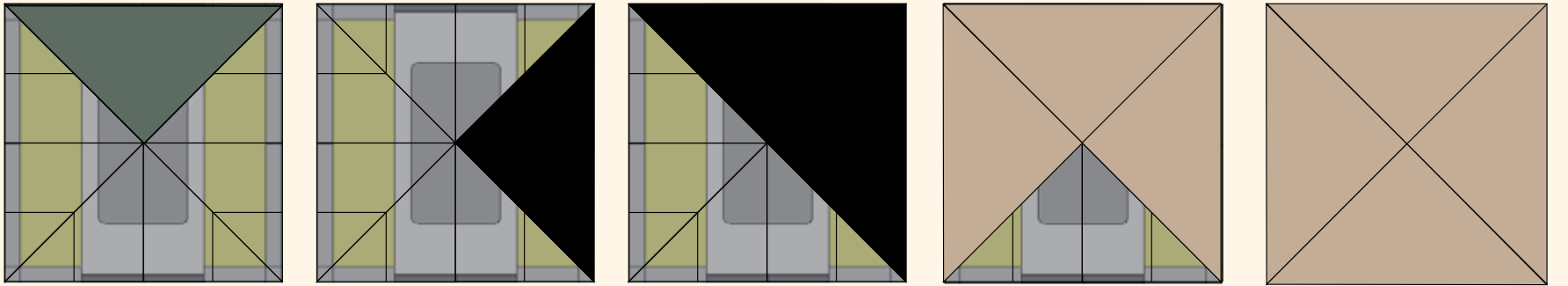

*TRANSLUCENT GLASS*

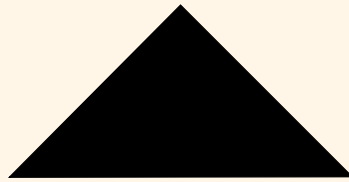

*OPAQUE GLASS*

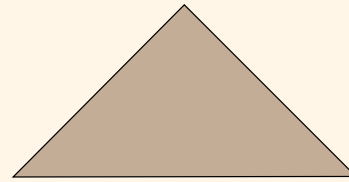

*CEDAR SHINGLES*

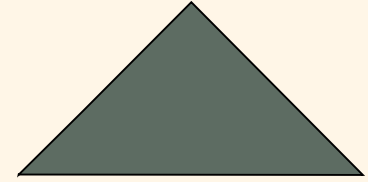

*TAPCO SLATE*

*The glazing fitted in our Sun Lounge roof is available in both translucent and opaque transparencies. The translucent glass is tinted to reduce the amount of light transmitted into the sun lounge to reduce glare on days of strong sunshine.*

*We recommend when choosing a roof option which includes cedar shingles, that the shingles should be applied to at least three quarters of the roof space.*



*Winter months are made comfortable with the electric 2.4KW heater*

## *A space for all seasons*

*Oceania Sun Lounges are designed to be a relaxing get away. The enclosed design, created by our weatherproof shutter system, provides a comfortable space to enjoy your gardens transformation through the seasons of the year.*

*Western Red Cedar exhibits a much higher insulation value than many other timber species. A higher insulation value, makes an Oceania Sun Lounge more economical to heat through the winter months whilst helping to keep the building cool in the summer.*





## *Blinds and Heating*

*solar and weather blinds can be installed to both the roof and side space of our Sun Lounge. Our blinds have been specially designed to offer stability, ease of operation and flexibility.*

*For a more comfortable experience, our Sun Lounge is fitted with a stainless steel electric heater and L.E.D down light. The easy to use radiant heater is fitted to the under-side of the sun lounge roof from chains. The heat is sure to keep you and your guests warm during those spring, summer, autumn and winter evenings. The style of heater benefits from rapid heat up and dual setting output. Double glazing and insulation are available as optional extras.*





## *Electrics and Lighting*

*Our Sun Lounges are installed with a tailor made layout of power sockets and light fitting options.*

### *Mood Lighting*

*To complement the light produced by the central heater unit, mood lighting is installed in the eaves of the building. The lights offer a range of colour options and is operated with a remote control.*

### *Power Points*

*Power points are installed in the Sun Lounge to allow a convenient power supply to low demand appliances.*

*All electrical consuming fixtures and accessories fitted in the Sun Lounge are wired to a central consumer unit which is equipped with RCD protection for safety.*

*The electrics will need connecting to your local domestic power supply by your own appointed electrician or competent person.*

*As optional extras we can also supply integrated fridges and home entertainment systems.*

*Additional furniture can be designed to create smart and discreet storage solutions. The seating in the Sydney and Darwin Sun Lounges provide generous hidden storage space.*





## *Our Certification -PEFC - the responsible choice*

*PEFC is an internationally preferred eco-label for sustainable forest management. Forest certification ensures that forests are managed according to environmental, social and economic criteria.*

*Our PEFC Chain of Custody certification along with our supply companies certification create a verified mechanism for tracking certified materials from the forest to the final product.*

- *Maintenance and improvement of biodiversity*
- *Protection of ecologically valuable areas*
- *Prevention of deforestation*
- *Consideration of the rights of indigenous people*

## *Our Staffordshire Workshops*

*Our site for manufacturing garden buildings is located in the rural Staffordshire countryside and combines three workshops to offer over 30,000 sq ft. Ample space allows us to dry assemble buildings- perfect for bespoke joinery which require hands on craftsmanship and custom machine work. Our qualified craftsmen from the heart of Staffordshire create the most accurate hand assembled mortice and tenon joints and are dedicated to passing on their skills through our established apprenticeship program. Our skilled craftsmen work hard to ensure a fine and high quality finish to every Sun Lounge.*





*Our buildings can be made secure by lock and key*

*For further details or advice, please contact:*

*Tel: 01889 562610 Fax: 01889 565960*

*Website: [www.oceaniasunlounges.co.uk](http://www.oceaniasunlounges.co.uk) E-mail: [sales@oceaniasunlounges.co.uk](mailto:sales@oceaniasunlounges.co.uk)*

*Workshop, Offices & Show site:*

*Woodpecker Joinery UK Ltd  
Olympic House, Bramshall Industrial Estate,  
Bramshall, Uttoxeter, Staffordshire, ST14 8TD*